

today

The ARBURG magazine

Issue 45

2011

JAHRE

ALLROUNDER

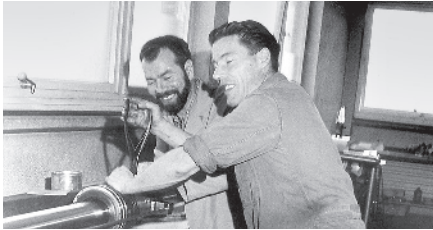

**4 Obituary for Karl Hehl:** An entrepreneur with the human touch

**6 50 years of ALLROUNDER:** An innovative idea revolutionises injection moulding



**8 Technology Days:** A highly impressive exhibition

**10 LEGO Group** wins 2011 Energy Efficiency Award

**12 Hongfa:** A global player in the production of relays and semiconductors

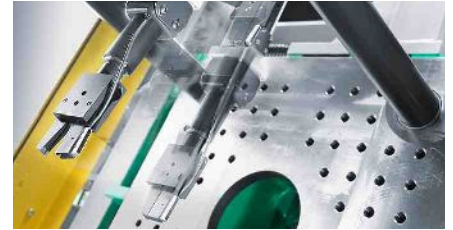

**14 New:** Electrical INTEGRALPICKER V

**15 Dens3000:** Plastic teeth injection moulded for the first time

**18 MIHB:** Complete service from Oyonnax



**20 EXJECTION®** now also endless and three-dimensional

**21 Optilight:** Innovative hybrid lenses for LED street lighting



**22 Mentor:** Long-established company specialises in optical waveguides for the automotive sector

**24 OBE:** Developing new markets with metal injection moulding components



**26 Tech Talk:** SELOGICA features for efficient production

## MASTHEAD

today, the ARBURG magazine, issue 45/2011

Reprints, including excerpts, may be made with permission only.

**Responsible:** Matthias Uhl

**Editorial advisory board:** Oliver Giesen, Juliane Hehl, Martin Hoyer, Herbert Kraibühler, Bernd Schmid, Jürgen Schray, Wolfgang Umbrecht, Dr. Thomas Walther, Renate Würth

**Editorial team:** Uwe Becker (text), Dr. Bettina Keck (text), Markus Mertmann (photos), Susanne Palm (text), Oliver Schäfer (text), Vesna Sertić (photos), Peter Zipfel (layout)

**Editorial address:** ARBURG GmbH + Co KG, Postfach 1109, 72286 Lossburg, Germany

**Tel.:** +49 (0) 7446 33-3105, **Fax:** +49 (0) 7446 33-3413

**e-mail:** today\_kundenmagazin@arburg.com, www.arburg.com

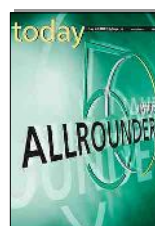

The Technology Days herald the start of the world-wide celebrations of "50 years of ALLROUNDER".

**ARBURG**



## Dear Reader,

Last autumn, everyone was excited to find out what trends the industry's international barometer, the "K" trade fair, would set for the future. And as we all hoped, the trade fair was a resounding success and this positive trend has continued into the new year. We are steaming ahead into 2011 and our production is currently working at full capacity. The only piece of bad news for our customers, and so also for us, is that delivery times have become longer. As our customer, however, you can rest assured that we are doing all we can to find satisfactory solutions. And we can promise you something else: from ARBURG, you will always receive top-quality injection moulding solutions – expertly manufactured, assembled with care and comprehensively tested at our central high-end production plant in Lossburg. We have remained true to this strategy for decades and the same applies to the unique modularity of our injection mould-

ing machines. Their origin and development is highlighted in a retrospective of the life's work of our late senior partner Karl Hehl and an article on this year's anniversary, "50 years of ALLROUNDER".

The fact that we are not resting on our laurels, but are working together with our partners on future-oriented processes and projects, is demonstrated by examples such as EXJECTION® endless technology, the "Optilight" joint project and the injection moulding of teeth, which we present to you in this issue. Further articles include exciting customer reports, interesting information from the world of ARBURG and practical tips for everyday injection moulding activities.

I hope you enjoy reading our latest issue.

Michael Grandt

Managing Director Finance and Controlling



# A modest visionary

## Obituary for Karl Hehl: An entrepreneur with the human touch

**T**echnical genius and senior boss of ARBURG – a life-affirming, ever cheerful man with a great deal of heart and intellect. These two dimensions – and a few others – characterised Karl Hehl throughout his life.

Of course, we can only cover a small number of examples in a retrospective of Karl Hehl's life's work. There wouldn't be enough space to include everything else. But a few impressions of his life and work already reveal a distinguished individual.

---

### Tinkerer and inventor

---

Karl Hehl was born in Lossburg in 1923, the founding year of Feingerätefabrik Arthur Hehl GmbH & Co. KG.

If ever there was a person who embodied the spirit of the typical Swabian "tinkerer and inventor", it was Karl Hehl. A perfect blend of determination and singleness of purpose, down-to-earthness and modesty made him the person he was: the technological thought leader and driving force of ARBURG.

A tough apprenticeship in precision engineering and the time away from his family left its mark on him, as did the fact that at 17, he was conscripted to serve in World War II. But even then, Karl Hehl contributed significantly to the fortunes of the Feingerätefabrik Hehl. During the war in France, he also developed the ARBURG logo. Karl Hehl always said: "As long as I live, this won't change."

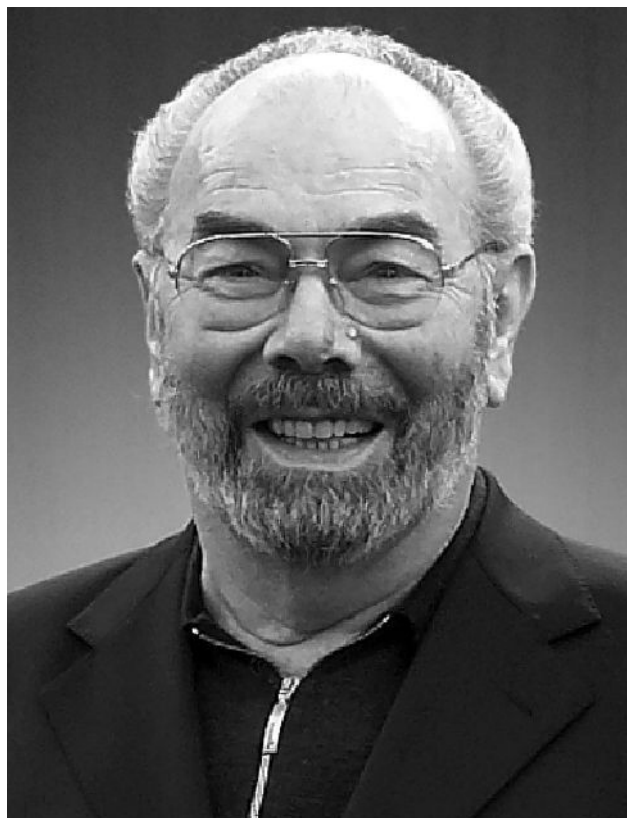

The only exception that he endorsed was the addition of the green bar beneath the original lettering. And developments have proven him right: because of its unusual typography, the ARBURG logo is instantly and clearly recognisable all over the world.

---

### Perfectionist

---

Karl Hehl's perfectionist streak was also evident in the implementation of his numerous ideas. He only ever said what he knew to actually be true. And Karl Hehl's word was his bond. Both customers and employees could always rely on that. He promoted free thinking among his employees with a high degree of trust, which partly stemmed

from his own sentiment. He was an entrepreneur with a very good insight into human nature and was always true to his word. As an engineer, Karl Hehl was a visionary, a pioneer, a designer and an inventor. At the same time, he was also a producer and a man of action with an good eye for the practical applications of his designs in production. New developments not only had to work well, they also had to be designed to allow the most cost-effective production possible. Their design always had to enable his technical ideas to be implemented in as few production steps as possible.

---

### Technological milestones

---

Karl Hehl was also the force behind numerous technological milestones. In the late '50s and early '60s, the pneumatic C machines, which were based on the C1, the legendary hand-operated injection moulding machine for encapsulating metal connectors, created a sensation. These were followed in 1961 by the hydraulic "original ALLROUNDER" as the brilliant basis of all further developments. However, the ALLROUNDER principle essentially only built on what the C1 already had: the end of the rigid horizontal arrangement of clamping unit and injection unit.

Further highlights of his achievements include the legendary ALLROUNDER 260 dual-platen machine dating from 1970 and the ALLROUNDER H, the world's first mass-produced machine to



feature HydronICA microprocessor control and proportional valve technology with stroke measurement as standard. These were followed by the ALLROUNDER CMD, which was groundbreaking in terms of its automation and graphic user interface, the VARIO principle of the horizontally displaceable injection unit, the electric ALLROUNDER A injection moulding machines and SELOGICA control technology.

In addition to his ideas and patents, many awards also bear witness to Karl Hehl's great technical understanding and to all that he did for his company and his region. At ARBURG, he remains in our memories in both word and in deed.

For he himself was what he often exclaimed when he wanted to call attention to a point during discussions: "Amazing!"

Highlights of a unique life: Karl Hehl was devoted to engineering and presented it with great pride. In 1954, the first ARBURG injection moulding machine (photo 1), in 1970, the cast iron part for the first two-platen machine (photo 2) and in 2009, the drive plate for the ALLROUNDER 920 H (photo 5). He always liked to pitch in himself, as for example during cylinder installation in the 1970s (photo 3), and to receive high-level visitors such as the then Minister President of Baden-Württemberg, Erwin Teufel, in 2000 (photo 4, right).





# Focus on customers

## 50 years of ALLROUNDER: An innovative idea revolutionises injection

**B**ack in 1961, ARBURG had the innovative idea of designing a modular injection moulding machine that was flexible enough to be used for a variety of different tasks. Ever since, the ALLROUNDER has set standards world-wide in the plastics processing industry. 50 years of the ALLROUNDER philosophy have made us a leading global company and one which reliably masters all injection moulding processes, develops new technologies with enormous expertise and has a perfect solution to hand, whatever the specific customer requirements.

Fifty years ago, ARBURG set out to revolutionise injection moulding technology. The ALLROUNDER 200 was the world's first injection moulding machine to feature a pivoting clamping unit and interchangeable injection unit. This recipe for success was as ingenious as it was simple: if the customer so wished, one and the same machine was able to work in seven different positions and so replace an entire machine fleet. The modular principle enabled a diverse



range of possible applications. The original ALLROUNDER machine mastered the processes of injection moulding, blow moulding and extrusion. It could encapsulate inserts and process elastomers as well as thermosets. In addition, the innovative ARBURG solution paved the way for multi-component injection moulding technology. Breaking with the principle of a rigid construction made extremely flexible working possible.

---

### Modularity points the way

---

Today, ARBURG has remained true to its philosophy of modularity in accord-

ance with the principle that technology must be practice-oriented and as universal as possible. However, while in the old days there was a single machine for all applications, today the ideal machine is designed for each application and each production requirement – from simple injection moulding solutions through to complex turnkey systems. This is made possible by the unique ARBURG product range, which comprises a modular system of mutually compatible modules. The individually configurable ALLROUNDER machines that can be created from this system can be used for the most diverse applications and processes.



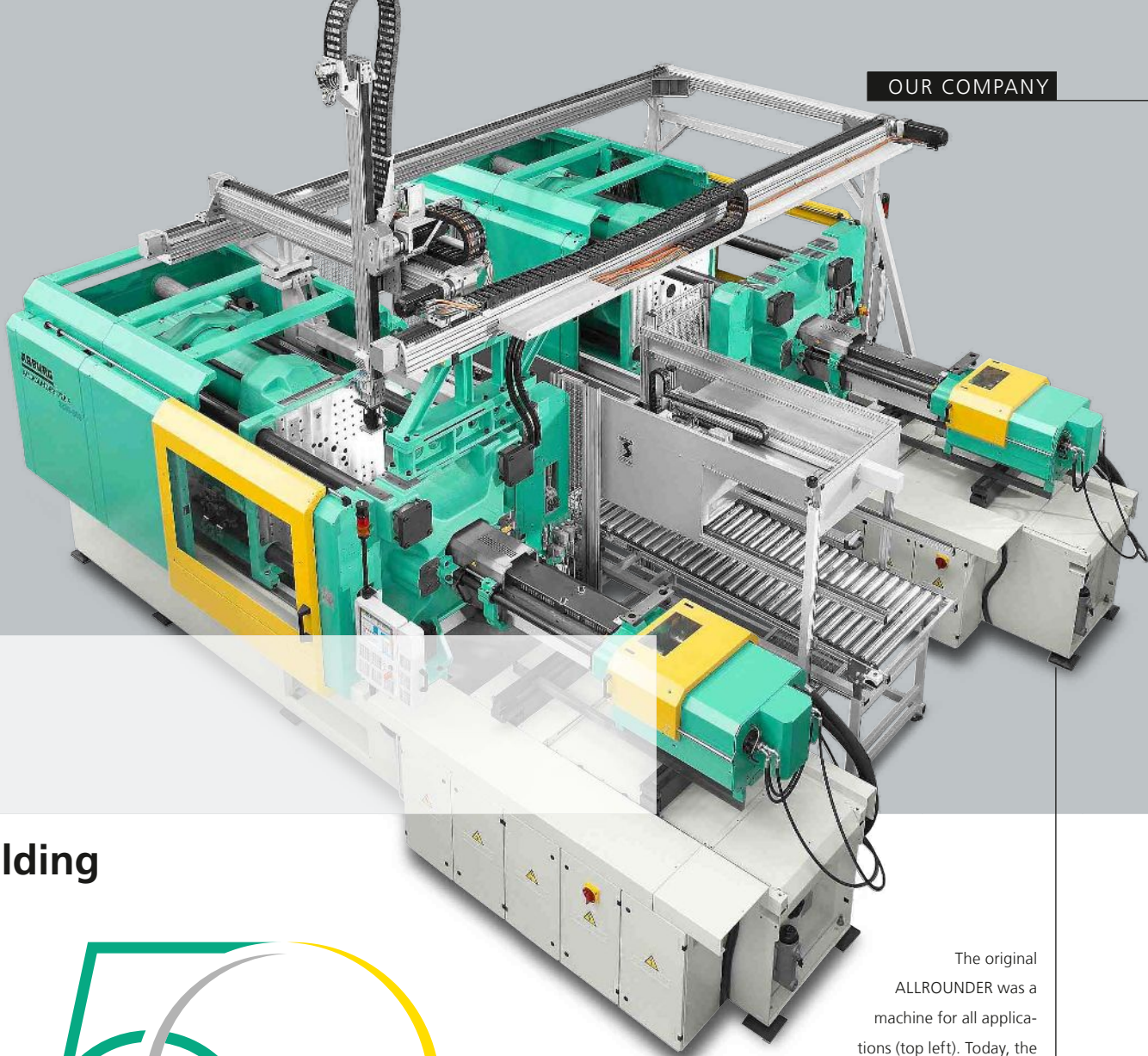

## Injection moulding



The original ALLROUNDER was a machine for all applications (top left). Today, the ideal machine for each application is individually designed from the modular product range (top right).

### Custom-built professionals

Unlike a ready-made jack of all trades, our ALLROUNDER machines are custom-built professionals – high-quality, efficient and reliable. Each injection moulding machine is virtually a one-off. Our highly trained employees are also true all-rounders. With a great deal of know-how, they help to optimise entire production processes and perfect our injection moulding solutions down to the last detail.

This is why the ALLROUNDER remains the world's most successful injection moulding machine to this day. We

regard this as both an incentive and an obligation, and so it will remain in future. Moreover, thanks to the standardised dimensions and compatibility of the machine components, all the prerequisites are in place for mass-producing technically perfect machines at attractive prices.

### INFOBOX

#### Advantages of the modular ALLROUNDER philosophy:

- Greatest possible flexibility, e.g. in the combination of drives as well as injection and clamping units
- Wide variety of expansion levels, including complete production cells
- Central management via SELOGICA machine control system, developed and built by ARBURG
- Easy adaptation to any process





Visitor groups from all over the world, e.g. more than 100 guests from Brazil in 2010, over 40 exhibits with innovative applications, individual advice and fascinating specialist presentations make the Technology Days a unique event in the industry's calendar.

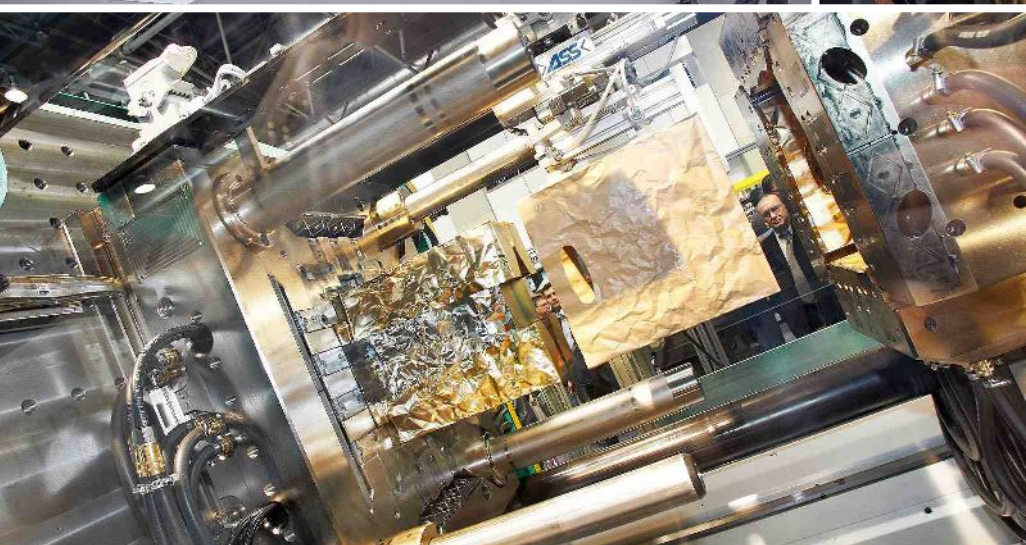



# Something for everyone

## Technology Days: A highly impressive exhibition

**E**very year, the Technology Days are an overwhelming success all over again. And the expectations of our guests, who travel to Lossburg from all over the world, are correspondingly high. An interesting fact is that around 50 percent of these are first-time visitors.

This faces us with the challenge of introducing ARBURG and the products comprehensively to the newcomers, while also presenting innovations and future trends to the regulars. But thanks to the wide-ranging programme, the Technology Days always manage to cover the interests of all the visitors. And in 2010, for example, "all" meant over 4,100 trade visitors from 46 countries!

### Personal contact despite size

Individual support is and remains extremely important, which is a remarkable accomplishment considering the crowds of visitors. This is why this year, for the first time, the event has been extended from three to four days. So from 23 to 26 March 2011, even more time will be available for personal discussions.

For those who wish to experience ARBURG in its entirety, the Technology Days are indispensable. For only here can you find:

- An exhibition space that extends over the entire company and provides first-hand insights
- All contact partners, from consulting

and technology through to service

- The complete ALLROUNDER range with clamping forces from 125 kN to 5,000 kN, with hydraulic, hybrid and electric drive concepts, as well as vertical machines
- A wide variety of robotic systems and customised automation solutions
- A diverse range of applications, including micro-injection moulding, multi-component technology, LSR, thermoset and powder injection moulding, clean room technology and assembly injection moulding

### The entire product range on show

Over 40 exhibits impressively demonstrate that ALLROUNDER machines cover all areas of injection moulding and all sectors, therefore doing their name proud. At this event, we also pay homage to their origins because this year, in 2011, ARBURG is celebrating "50 Years of ALLROUNDER" (see p. 6). As befits the occasion, a presentation will shed more light on the transformation from the erstwhile ALLROUNDER principle to the ALLROUNDER philosophy of today. A vital element of our success story over five decades is also the strong spirit of development, with which ARBURG continuously expands its modular range of products.

### New electric machine series

The most recent example is the addition of a completely new series – the ALLROUNDER EDRIVE – to our range of electric machines. This series will be repre-

sented by four exhibits and its design and range of applications will be presented in detail.

Further topics of expert presentations



are the advantages of the new SELOGICA features, the integrated UV painting of moulded parts (Sturm Holding GmbH), the innovative cube mould technology (FOBOHA GmbH) and energy management in an injection moulding production plant (gwk Gesellschaft Wärme Kältetechnik mbH).

This unique blend of theory and practice amply demonstrates that the Technology Days always cover the interests and key issues of all our guests, so that everyone is sure to take new ideas home with them.





# The right strategy

## LEGO Group wins Energy Efficiency Award 2011

**T**he LEGO Group has been presented with the ARBURG Energy Efficiency Award 2011 for its exceptional global energy and environmental activities. The extremely high priority awarded to these topics is based on the strong responsibility towards children, which are also seen “as heirs of our planet.”

The philosophy of the LEGO Group is that “good play” enriches the lives of children – and consequently their subsequent adult life. Accordingly, the company markets a broad range of products.

---

### “Only the best is good enough”

---

The quality requirements with regard to the products and therefore to suppliers are exceptionally high. During injection moulding of the world-famous LEGO bricks, tolerances of 10 µm (0.01 mm) must be met. The reasons for this are at (or when playing ‘in’) hand. Since 1958 all



At LEGO nothing is left to chance: Finn Stenager Juhl calculates the energy consumption of the injection moulding machines under practical conditions

LEGO elements, which have been manufactured world-wide, are compatible with one another.

In order to produce these high-precision parts, the LEGO Group has relied on ARBURG for decades. This successful co-operation has resulted in numerous joint developments for the injection moulding sector. In addition to precision, energy-efficiency also plays an important part here.

---

### Environmental awareness a priority

---

From the very outset, the company has taken every possible opportunity to act and produce in an environmentally sound manner throughout the Group. A further step in this direction was taken in 2007 with the introduction of an energy and environmental management system. The success of the system is evidenced by the fact that energy efficiency was improved by 35% between 2007 and 2010 and thereby considerably exceeded the target of 10% energy efficiency. This demonstrates that the “Planet Promise” initiative of the LEGO Group is not merely a theoretical promise, but that it has been transformed into measurable strategic goals. These include an annual energy-efficiency increase of 5% from 2011 until 2015 and the 100% procurement of energy from renewable sources by 2020 – worldwide.

---

### Energy savings during injection moulding

---

“In order to effectively tackle the issue of energy saving in the long-term, the individual sources of consumption



Photos: LEGO

must be identified, potentials recognised and measures determined,” says Harald Karlsen, Global Energy Manager. A high significance was given to the injection moulding area here, which accounts for 72% of energy consumption, of which 68% is attributable to the injection moulding machines. It is therefore particularly important to stay on the ball in this regard. One example is the current “Moulding Next Generation” project with which energy consumption – in relation to the material quantity processed per hour in kg - is to be reduced by some 46%. “In order to achieve this objective, we have set maximum values dependent on clamping forces and drive systems,” explains Finn Stenager Juhl, who together with the Process and Education department, carefully and thoroughly tests new injection moulding machines before they are implemented in production.

In addition to the injection moulding sector, numerous measures are implemented in the areas of compressed air, pumps, cooling, ventilation and lighting, such as continuous leak monitoring, free cooling and the use of high-efficiency lamps. The topic of energy efficiency thus extends to all business units, worldwide.



---

### Delight at the award

---

"We are delighted to receive the ARBURG Energy Efficiency Award and we are proud that our activities have been honoured. Furthermore, the prize also motivates us to continue identifying new energy-saving potential in the future", says Helle Sofie Kaspersen, Vice President for Governance and Sustainability. "In addition, we see that as a result of the good partnership that has been built over the years between the LEGO Group and ARBURG", adds Michael McNulty, Vice President for Global Procurement.

### INFOBOX

**Founded:** 1932

**Locations:** Production in Denmark, Hungary, Czech Republic and Mexico

**Turnover:** 11,661 million DKK in 2009

**Employees:** Around 8,000 worldwide

**Machine fleet:** Around 1,200 injection moulding machines worldwide

**Moulds:** 7,000 worldwide

**Material:** Mostly ABS, daily consumption approx. 60 tonnes

**Product range:** Some 7,500 combinations from 3,900 different pieces and 58 different colours

**Contact:** [www.lego.com](http://www.lego.com)

---





# A giant

Hongfa: a global player

**T**echnology is the root of success, talent the foundation of success and innovation the spirit of success! – With this paraphrase, so eloquent to Western ears, Xiamen Hongfa Electroacoustic Co.,Ltd., the largest Chinese and globally leading manufacturer of relays, semiconductors, low-voltage units and connectors, illustrates its efforts to always employ the best production technology in order to supply its globally dispersed customers with high-quality products in an intensely competitive market.

Since 1994, Hongfa has relied on the support of ARBURG for these activities. Hongfa's philosophy is: "Never rest on our laurels, make continual progress!" The company is market-orientated, with a strong focus on quality. Established in 1984, Hongfa today operates 16 locations with a total production area of some 30,000 square metres, in which an annual unit volume exceeding one billion relays was manufactured in 2010. In 2009, a total turnover of 270 million US dollars was achieved. This turnover was increased in the year 2010 by approx. 35 % to 363 million US dollars.



Photos: Hongfa

# in small things

## r in the production of relays and semiconductors



Hongfa (top) is a leading producer of relays, both nationally and internationally, not least thanks to the ALLROUNDER injection moulding technology employed throughout (bottom left).

### Positioned first in China

Success has its effects: Hongfa is the only Chinese relay manufacturer to be certified as a national export company for automotive components by the Chinese government. With a market share of 21 percent of total relay production, Hongfa is positioned first in terms of economic efficiency within the Chinese relay industry. Since 1995, the company also ranks 24th among the top 100 Chinese electronic component manufacturers.

Hongfa products are used in the automotive, telecommunications, safety and control industries, in domestic appliances, as well as in aerospace applications. Their customer list reads like a Who's Who of the global economy: It includes names such as Siemens, Mitsubishi, General Motors, Ford, ABB, Alcatel, Phoenix and Viessmann.

Hongfa supplies an extremely comprehensive range of relays: from signal, low-voltage and automotive relays, through to hermetically protected components, the relay giant produces more than 160 series with over 40,000 standard specifications. This requires high-tech production, in

which the 130 ALLROUNDERs represent the key technology. The objectives are also clearly set in this regard: by 2020, the company wants to count among the top 3 in the global relay industry - with room for further advancement!

The priority placed upon quality is evidenced by the numerous certifications and qualifications held by Hongfa: ISO9001, ISO/TS16949, ISO14001, OHSAS18001, GJB9001A and IECQ QC 080000. The company has also been government-certified as an "excellent high-quality manufacturer". The products have been approved by UL&CUL, VDE, TÜV and CQC.

### Wide range of ALLROUNDERs in use

The company utilises virtually the entire spectrum of ARBURG machines, with clamping forces between 350 and 1,600 kN. An ARBURG host computer system (ALS) is also used in production in order to analyse and document the high production quality. ARBURG not only ensures top performance and competitive prices, but also the satisfaction of Hongfa and its customers in 65 countries worldwide, thanks to its excellent technical support services.

Since its foundation, Hongfa has always focussed on the highest possible degree of technological innovation. Investments have continuously been made in the relay production technology currently available world-wide. New developments are being implemented with regard to the 3D CAD process and 134 patents evidence the intensity of the research and development activities. The Hongfa Testing Centre is the largest testing and analysis facility of its kind in the People's Republic. Hongfa works very closely with the VDE in testing electronic components.

Certification by the research and analy-

sis institutions as well as by American inspection organisations demonstrate that all the technology used by the company operates to perfection - just like the ARBURG ALLROUNDERs on which parts for Hongfa's relays are produced smoothly in millions of units.

### INFOBOX

**Founded:** 1984 as Xiamen Hongfa Electroacoustic Co.,Ltd.

**Locations:** 16 throughout China

**Products:** 160 relay series with 40,000 standard specifications

**Customers:** automotive, telecommunications, safety and control industries, domestic appliances, aerospace

**Contact:** [www.hongfa.com](http://www.hongfa.com)



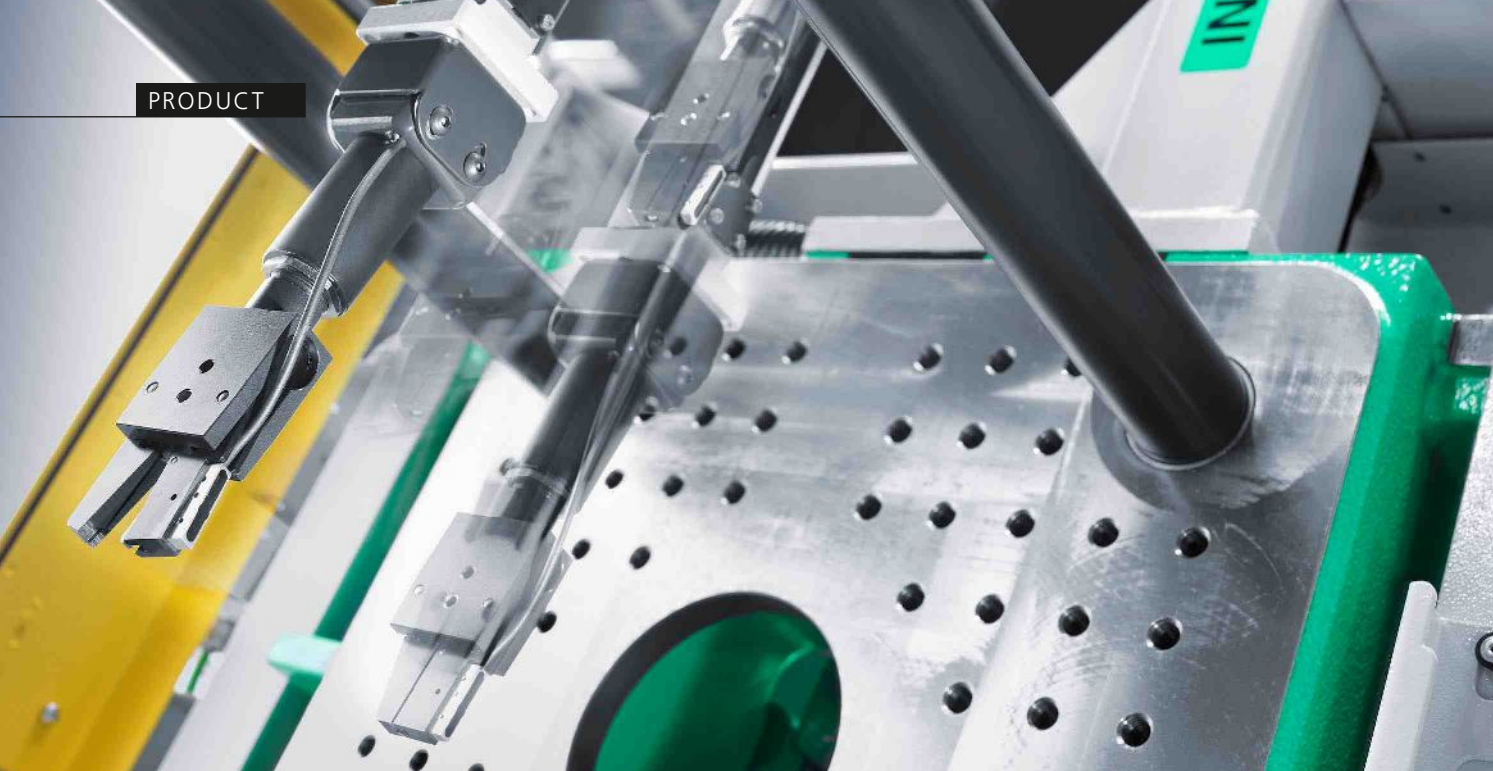

# Simply brilliant, brilliantly simple

## New: Electrical INTEGRALPICKER V

**H**ow brilliant a solution is usually only reveals itself upon closer examination. A good example of this is the electric INTEGRALPICKER V. This robotic system, developed specially for reliable sprue removal on ALLROUNDERS, has a highly practical overall design that enables considerably shorter set-up and cycle times than the pneumatic devices commonly found on the market.

An important feature of ARBURG's new picker solution, which enters the mould vertically, is its powerful and energy-efficient drive technology. The three servo-electric movement axes dispense with the need for set-up work during order changes.

### Mould entry more than one second faster

The servo motors also enable significant cycle time reductions of more than one second. For example, with an

acceleration of 20 m/s<sup>2</sup>, the entry axis is exceptionally dynamic and reaches speeds of up to 20 m/s. All this is combined with highly repeatable accuracy. Furthermore, any number of axis positions can be programmed, such as an intermediate stop (waiting position) above the mould, for instance. Another major advantage is the simultaneous, stroke-dependent movements within the robotic sequence and in relation to the machine sequence. For example, the entry axis can safely be started even while the mould is opening, and the removal and ejection movements can be synchronised.

### Set-up in just three minutes

However, this only becomes possible if the picker is fully integrated in the SELOGICA machine control system. In other words, only one data record for the entire production unit, no re-thinking required of operators during programming. The interactive teach-in function allows fast, menu-guided set-up in only three



Practice-oriented for short set-up and cycle times: the electric, vertically operating INTEGRALPICKER V.

minutes, without detailed knowledge of the control system. The picker is therefore ready for operation immediately after each mould change.

Finally, the electric INTEGRALPICKER is completed by the CE-compliant guard with integrated ejection chute and free access to the mould. The result is a practical complete solution that is perfectly adapted to the injection moulding technology.



# Idea closes gaps in the mouth

**Dens3000: Plastic teeth injection moulded for the first time**

**T**ooth replacement no longer has to be expensive or low-quality: the young Dens3000 company has now succeeded in producing teeth made from PMMA thermoplastic for prostheses using the injection moulding process. The plastic teeth "Made in Germany" satisfy the most stringent quality requirements – with no finishing work required. A special two-component solution has been developed and patented jointly with ARBURG experts.

"I want to introduce a high-quality yet inexpensive plastic tooth onto the market and so make dentures that appeal to China and Eastern European countries," says Dr. Reinhard Lohse, medical physicist and founder of Dens3000, explaining his business idea. To put this vision into practice, he engaged production manager Hartmut Schmitt. This qualified plastics processing engineer and mould maker has around 30 years of experience in injection moulding.

"From the very beginning, ARBURG was willing to listen to our problems,



144 different PMMA teeth for prostheses: an ALLROUNDER 520 A produces eight parts in around 30 seconds.





which lay outside the conventional injection moulding field," says Dr. Reinhard Lohse. Hartmut Schmitt explains the peculiarities of the project: "For me, the product is not a tooth, but a complex moulded component with numerous free-form surfaces, undercuts and the most exacting requirements regarding surface quality."

Together with the ARBURG Project department, the mould manufacturer and a design office, a two-component injection moulding process, including an automation solution was designed in detail for Dens3000 and the machine technology precisely adapted to the project's specific requirements. The art of producing a plastic tooth in premium quality, which can be removed from the mould without visible separation marks, lies in the exact fine tuning of the material, mould and machine technology. Because high-precision parts with components weighing only 0.1 to 0.73 grams are being produced, an electric injection moulding machine was

the natural choice. The ideal contender was an ALLROUNDER 520 A with a clamping force of 1,500 kN and two size 70 injection units. The ARBURG experts developed a special cylinder based on a proven model, which feeds and homogenises the PMMA to be processed in an ideal manner.

#### **PMMA tooth 10 times cheaper**

In order for the teeth to look as natural as possible, they are produced from two plastics of differing hardness and colour. Only when the base body is combined with the enamel is the perfect appearance achieved. To obtain this result, the PMMA underwent several modifications and the teeth were tested at university hospitals. "Unlike plastic teeth, which are manufactured from thermoset by extrusion in the conventional way, our products are not prone to plaque or the formation of cracks," says Dr. Reinhard Lohse, "and the

Dens3000 Managing Director Dr. Reinhard Lohse (left) and Production Manager Hartmut Schmitt have succeeded for the first time in injection moulding plastic teeth for prostheses. They now want to develop markets in Eastern Europe and China.

price is 5 to 10 times lower." Four 8-cavity moulds are used to form all 28 teeth of a full set. The range includes 144 sample teeth in 16 different shades, three sizes and various shapes for individualised front teeth. The shot weights are between 2.5 and 5.6 grams, depending on the type of tooth. Following a cycle time of 22 to 30 seconds, the eight different moulded parts are removed by a MULTILIFT H robotic system and set down according to cavity. Precise positioning is ensured by a finger on the "root" of the tooth, which has the same shape for all teeth. This also contains an individual code. During the following injection moulding cycle, the



The process is now ready for series production, which is set to commence in the near future. Four electric two-component ALLROUNDER machines will then produce 20 million teeth a year in three-shift operation around the clock. To reduce downtimes to a minimum, Dens3000 has concluded a service contract with ARBURG, which schedules preventive maintenance at regular intervals.

The MULTILIFT H robotic system deposits the teeth for cooling, sorted by cavity (top). Colour measurement (left) is part of quality assurance.

teeth are cooled and then separated via a system of tubes. Samples of the teeth are removed every two hours for the purpose of quality control. This includes inspection of the colour, for example, and measurements of the hardness and weight. Once incorporated in the prostheses, the teeth have a useful life of around five to ten years.

### 20 million teeth a year

Hartmut Schmitt at the Kusel production plant in Rhineland Palatinate has carried out several hundred tests since March 2010. Optimisation, mould development and mould evaluation took about a year.

## INFOBOX

### Teeth made from PMMA for the first time: Thermoplastic instead of thermoset or ceramic

- High product quality without finishing work
- Patented multi-component injection moulding
- Eight different tooth types per cycle (moulded part weight 0.24 to 1.1 g)
- A single machine can produce up to 8 million teeth a year
- Co-operation with the institute of materials technology and plastics processing (IWK) Kaiserslautern, as well as Regensburg and Homburg/Saar University hospitals



# Compre

Moulages Industriels d



**E**ngineering and the production of sophisticated technical components are MIHB's core areas of expertise. The specialists here support their customers, from the initial idea to the finished components. According to Managing Director Frédéric Jullien, they understand their company slogan "Transform to success" as a complete range of system services. In the area of multi-component injection moulding, in particular, MIHB is a highly competent partner – with the aid of ALLROUNDER machines from ARBURG.

MIHB's history begins quite conventionally: Marcel Jullien and his wife founded the company in 1969 with just six employees in order to produce small technical parts for the watchmaking industry and articles for the sport, leisure and domestic goods sectors. They then developed at a swift pace: the original 300 square-metre production area has now grown to 10,000 square metres at five sites in France and Hungary. Initially focusing on injection moulding, MIHB today also offers technol-

Marc Schuh, Manager of the ARBURG subsidiary in France, and MIHB Managing Director Frédéric Jullien (from left to right) are convinced: high-quality technical parts and high-end injection moulding technology belong together.

ogies such as extrusion and blow moulding through a subsidiary.

## High-tech solutions

The machine fleet of MIHB's injection moulding division covers a clamping force range from 250 to 5,500 kN. More than 80 percent of the machines are ALLROUNDERS, which is no coincidence, as Ivan Audouard, Technical Manager, explains: "Above all, we value our professional co-operation with ARBURG, which started in 1970," he says. He regards service and reliability as particularly worthy of mention. "The close co-operation, the comprehensive advice, plus ARBURG's wide product range and high-tech solutions have all contributed to our company's success," adds Frédéric Jullien, Managing Director of MIHB.



# Comprehensive offerings

## MIHB (MIHB): Complete service from Oyonnax

### Highly automated machine fleet

All the machines are equipped with removal pickers and robotic systems, including three with six-axis robotic systems. The different materials – such as PA, PPA, POM, PC and PETP, sometimes glass-fibre-filled – are prepared centrally and conveyed to the machines.

The main target of the production range is the automotive sector, with 35 percent of parts being destined for fuel systems, 20 percent for vehicle safety, 20 percent for the instrument panel, 13 percent are gears and 12 percent are car keys. Inserts are encapsulated in the mould for this purpose. In complex multi-component applications in particular, comprehensive quality assurance is vital. This is ensured by the features of the SELOGICA machine control system on the one hand, and by means of an SPC system and the visual inspection of certain product-specific areas on the other. In addition to Europe, South America and Asia are major sales markets for MIHB products.

### Specialist for multi-component parts

MIHB has made a name for itself as a specialist for multi-component parts. The ALLROUNDER machines it operates include two and three-component models, but also machines for gas injection technology and the IMF (Injection Moulding Forming) process. Several integrated downstream production cells assemble various parts into finished components with online monitoring.



Automated production cells with six-axis robotic systems produce technical parts at MIHB.

### Preventive maintenance via contract

The ALLROUNDER machines are serviced jointly by MIHB and ARBURG. Since the summer of 2010, this has also taken place by means of a service contract. This ensures that all the machines continue to operate perfectly in five-day multi-shift operation thanks to preventive maintenance intervals and the regular replacement of wearing parts. Ivan Audouard has this to say: "The ALLROUNDERS' strength, in addition to their reliability, is their reproducibility and accuracy. Moreover, the user-friendly SELOGICA control system has moved us to initiate forthcoming tests with a MULTILIFT robotic system fully integrated in the SELOGICA in order to comprehensively test the 100 percent integration of production and handling."

### INFOBOX

**Founded:** 1969 by Marcel Jullien and his wife.

**Employees:** 220

**Turnover:** 30 million euros annually

**Locations:** France (4) and Hungary

**Products:** Technical parts for the automotive, electrical, aircraft construction and packaging industries using one, two and multi-component technology.

**Special features:** Gas injection technology, extrusion and IMF (Injection Moulding Forming) processes

**Machines:** 60 injection moulding machines in France, another 20 in Hungary, clamping forces from 250 to 5,500 kN

**Contact:** [www.mihb.com](http://www.mihb.com)





DEVELOPMENT

# Reeling it off

EXJECTION® now also endless

**E**XJECTION® technology was previously restricted to moulded parts with a maximum length of two to three metres. Since the first EXJECTION® endless mould ran on a hydraulic two-component ALLROUNDER 570 S last year for the "launch customer" SaarGummi, a leading supplier of seals for the automotive industry, the range of applications for this technology has expanded significantly.

The idea of continuous injection using a movable cavity is responsible for this development: With the EXJECTION® endless technology, two previously incompatible processes have been combined as a world first. Now, components on a reel can be produced with simultaneous injection and cooling. The dry cycle times required in conventional injection moulding for closing and opening the mould and for component removal are completely dispensed with.

## Modular round cavity

The mould technology is a particularly fascinating aspect of this process. The formative cavity is of a modular design. The individual segments have a defined length and the mould is sealed all round. In this way, the cooled sections of the

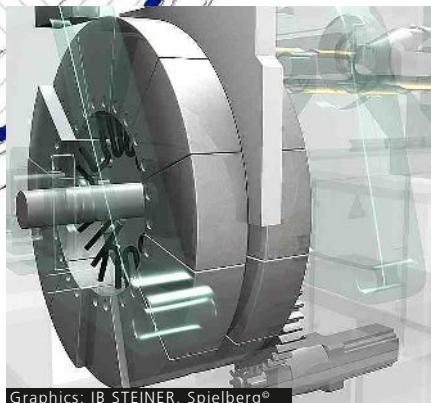

Graphics: IB STEINER, Spielberg®

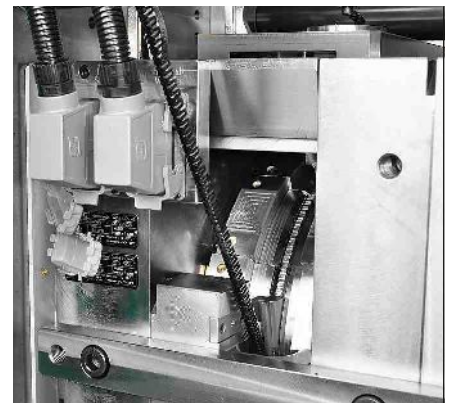

moulded part can already be removed while the mould is being filled. After demoulding, the empty elements of the cavity are conveyed back to the other end of the mould, where new melt is being injected. This process can either be linear, with a circulating chain of mould elements, or rotary, with the aid of a rotary table. The endless cavity is continuously filled with the melt by two injection units working in alternation on a conventional multi-component ALLROUNDER.

## SELOGICA controls entire process

A pressure-dependent switching valve in the hot-runner system is controlled via the SELOGICA and ensures a continuous flow of the melt. In this manner, the EXJECTION® endless mould process is fully integrated in the machine. Here, once again, the ALLROUNDER and SELOGICA demonstrate their unbeatable flexibility in the implementation of innovative techniques. Project partners SaarGummi International GmbH, IB Steiner, z-werkzeugbau-gmbh and

With EXJECTION® systems, very long components are produced with low clamping forces and 80 percent less energy consumption.

HASCO Hasenclever GmbH + Co KG envisage numerous areas of application for this new technology: automotive, aviation, electrical engineering and electronics, construction and medical technology – the possibilities are endless!

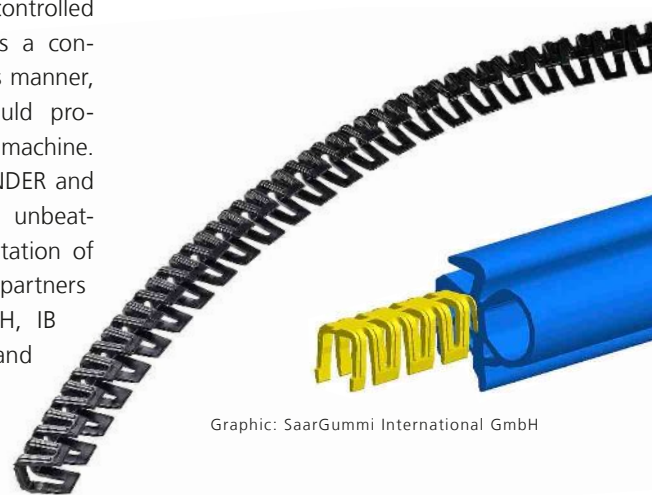

Graphic: SaarGummi International GmbH



# Glowing example of energy efficiency

## Optilight: Innovative hybrid lenses for LED street lighting

**A**t ARBURG, energy-efficient operations that save resources have always been a priority – whether during production or with regard to the ALLROUNDER machines themselves. A project covering the production of innovative hybrid lenses for LED streetlights is therefore extremely well suited to our company. As a project partner, ARBURG is entrusted with manufacturing these lenses on ALLROUNDER machines using the injection compression process.

The background to this joint “Optilight” project is that the production of lenses for powerful public LED street lighting must become a great deal cheaper in order to be truly financially viable. The partners ARBURG, 3D-Shape, electronic services wilms, the Fraunhofer Institutes for Laser Technology (ILT) and Production Technology (IPT), GICS Leuchten, Innolite, S1 Optics and the Aachen public services are involved in the cooperation. The project is sponsored by the German Ministry of Education and Research (BMBF) and supervised by Projektträger Karlsruhe (PTKA).

### The goal of cost-efficient production

The energy-saving application possibilities would be numerous and extremely diverse – if only there was a cost-effective value-added chain. As well as the problem of acceptance by the public and traffic



authorities, the technology also faces technical challenges in the form of pole spacing, illumination, dazzle effect and other safety-relevant factors.

### Compression injection of hybrid lenses

The hybrid lenses with free-form surfaces developed in this project should help to eliminate the weak points mentioned above. The integrated free-form surfaces of these special lenses direct the light to precisely where it is needed. At the same time, the lenses exploit to the full the cost advantages of high volume production from plastic. In its final stage, “Optilight” will provide an efficient production chain for microstructured, thick-walled polymer hybrid lenses. This will then extend from design and organising the process through to high-quality series production via injection compression, a process that is ideally suited to the manufacture of thick-walled plastic parts. This should considerably

The focus is on illumination and energy efficiency: Hybrid lenses with free-form surfaces will precisely direct the LED light.

reduce expenditure on resources compared with conventional systems. Energy savings will also be achieved by comprehensive optimisation throughout the process chain by saving materials, reducing expenditure, shortening the process chain and adaptive control of the injection compression and in-mould lamination operations.

As well as designing the mould and machinery, ARBURG is also involved in the production of a prototype mould, which will cover both injection compression with mould tolerances of less than 5 µm for transmissive lenses and the in-mould lamination of films for reflective lenses. Demonstration models with suitably adapted LEDs will shortly be put to practical use in a street in Aachen. This will enable field analysis of how the new lighting is perceived by road users.



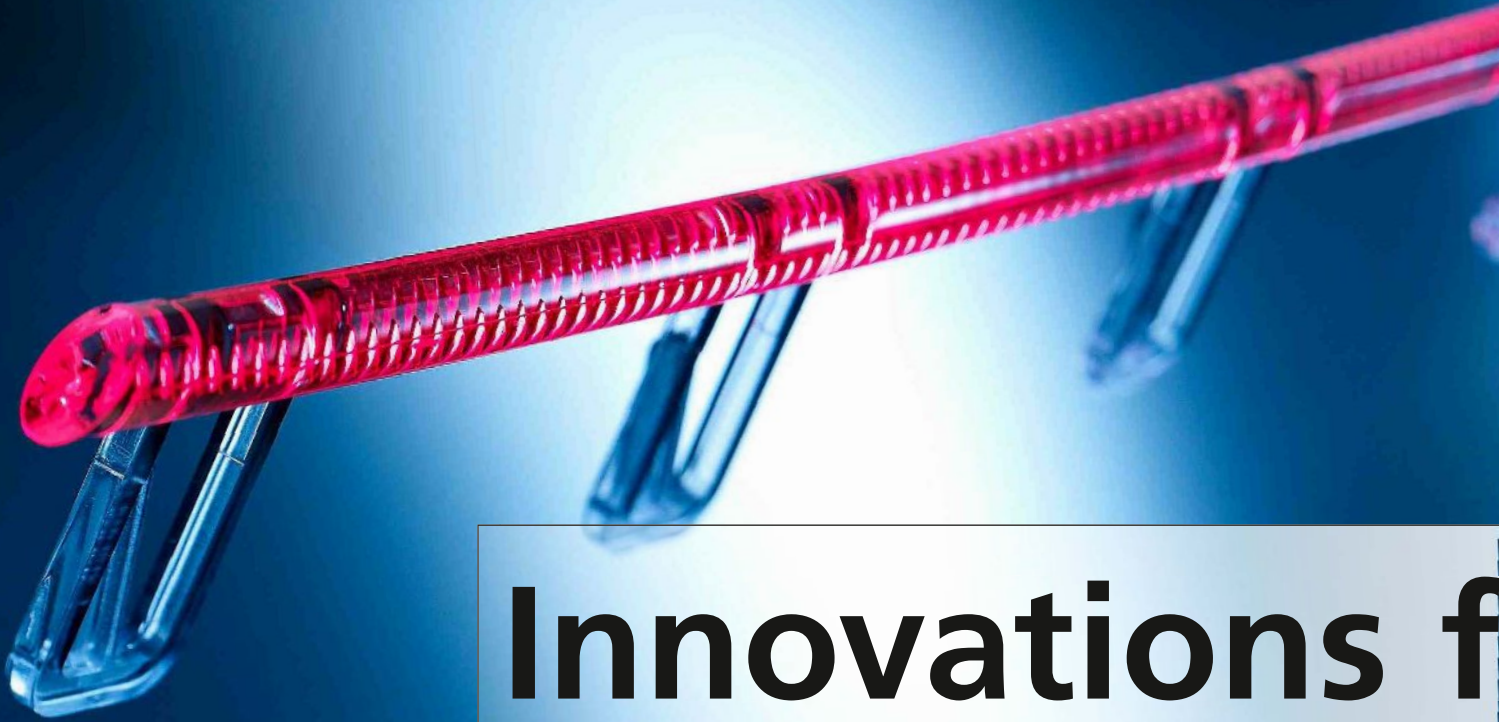

# Innovations f

## Mentor: Long-established company specialises

**W**ith this slogan, Mentor GmbH & Co Präzisions-Bauteile KG from Erkrath advertises its products. A company that stocks a product range of 11,500 individual parts and around 7,000 finished ones, ranging from micro components weighing only 0.006 g to injection moulded items with a length of 800 mm long is no common occurrence. As with its co-operation with ARBURG, the diversity of the range of both customised and standard items, has grown continuously: Mentor has been producing its entire product range exclusively on ALLROUNDERS for 40 years.

The company, which was established in 1920, currently manufactures 80 percent of its products from a huge variety of plastics, some glass fibre reinforced, and primarily intends to further expand in this sector. Marco D'Aurelio, Marketing Advisor, has this to say: "Today, Mentor produces plastic parts, components and assemblies for the mechanical, electronics and optoelectronics sectors, among others."

Their customers are primarily found in the fields of electronics/surface-mounted devices (SMD) and medical technology,

while the automotive sector is also positioned strongly with around 40 percent. Christian Broich, Production Manager at the injection moulding plant, remarks on the nature of Mentor's customers: "For the most part, we work with regular customers, who appreciate us and our skills as a system supplier. We mainly support our partners throughout the entire value-added chain. This ranges from development, design and mould making, through to production, subsequent machining, assembly, packing and delivery.

According to Marco D'Aurelio, the company's own sales organisation is also to be expanded in order to gain a greater share of the international market because so far, at 70 percent, the lion's share of Mentor products has gone to the German market.



### Microstructures for uniform light distribution

The company produces polymer optical waveguides in lengths between 4.5 and 800 mm. Says Christian Broich: "Above all, our specialist know-how includes the incorporation of microstructures along the entire length of the moulded parts in order to achieve uniform light distribution and output. These contours are particularly important because we only couple the diode light in these structures on one side."

An in-house developed, machine-based CAQ system is employed for quality monitoring purposes. Here, important machine parameters are recorded via a special interface for each shot and are 100 percent documented and monitored via the SPC statistical process control system. Of the company's 40 ALLROUNDER machines, 21 operate in shift operation in Erkrath, the remaining ones are lo-

Production Manager Christian Broich (bottom left) shows the optical waveguide that is injected vertically into a one-metre mould on an ALLROUNDER 420 C (bottom).



Optical waveguides for vehicle interiors (left) are a speciality at Mentor.

# or the future

## in optical waveguides for the automotive sector

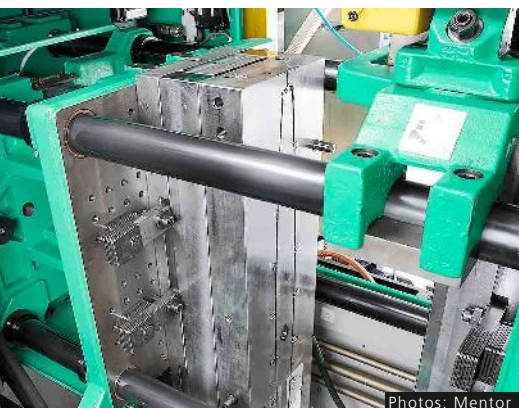

Photos: Mentor

### One-metre mould for optical waveguide

An ALLROUNDER 420 C particularly catches the eye in the production line: the machine operates with a maximum useful clamping surface of 600 mm and a round, 1-metre mould positioned vertically in the clamping unit. The single mould for producing the 800-mm optical waveguide extends down into the machine base and a size 250 injection unit injects vertically into the parting line. Christian Broich responds to questions with a smile: "How do I produce high-quality technical moulded parts in a large mould with such a small clamping surface? That's what a lot of people want to know when they see this and they all get the same answer: That's Mentor know-how."

We will say this much: the optical waveguides are made from PMMA and the mould contours are highly polished. The light-conductive geometry is milled and eroded, and has different characteristics for the different waveguide lengths. After a cycle time of 45 seconds, the parts are ejected and the sprue removed downstream by laser. Next, the parts are either delivered immediately, or sent to the assembly plant in Tunisia for the manufacture of components with LEDs and addi-

tional electronics. Christian Broich again: "We are extremely flexible with regard to our customers. In our opinion, intelligent light distribution with optical waveguides and LEDs holds enormous development potential for the future."

cated at the Mentor subsidiary Albert Weidmann Licht-Elektronik GmbH in Pforzheim. Christian Broich explains why Mentor has equipped itself exclusively with ALLROUNDER injection moulding technology: "For us, ARBURG brought all the positive factors together. First of all, the ALLROUNDER machines are compact, with high repeat accuracy and excellent availability. Secondly, the fast and flexible service by the ARBURG Technology Centre in Radevormwald is very important. Thirdly, we also benefit from the ALLROUNDER philosophy of compatible technology throughout virtually the entire product range, such as the universal suitability of the injection units, for example."

### INFOBOX

**Founded:** 1920

**Employees:** over 450

**Machine fleet:** 40 ALLROUNDERS with clamping forces from 250 to 1,500 kN, including vertical and two-component machines

**Products:** e.g. light-conducting components – including waterproof versions – into which 50 million LEDs are built annually

**Certification:** DIN EN ISO 14001, 9001 and TS 16949, listed as "Formula Q" A-supplier for VW.

**Contact:** [www.mentor-baelemente.de](http://www.mentor-baelemente.de)





# From s to surg

OBE: Developing new

**O**BE has established itself as a supplier to the precision mechanics industry. After specialising in the optics sector in the 1970s, since 1996 it has invested in metal injection moulding (MIM) technology and its own mould making plant.

OBE focuses on three business segments: metal injection moulding (MIM), precision mechanical spectacle components and industrial 3D image processing (surface inspection). The MIM sector now accounts for around one third of overall turnover. Its main focus is on small, high-precision metal parts in large unit volumes. These include resilient hinges for spectacles and special safety screws (diameter: 1.8 to 2.5 millimetres) for perfect retention of the lens.

In order to avoid dependence on a single industry, in 1996 the company decided to diversify. Because the company has

extensive core expertise in metalworking, the idea of embracing MIM technology seemed an obvious step. The company quickly realised the advantages of this technique over conventional machining. "Our extended product range suddenly became interesting for entirely new industries, such as telecommunications, automotive, medical technology and aviation," explains Josef Heckert, Technical Manager and MIM expert.

## Boldly stepping into new branches

The company's over 70 years of expertise in traditional metal working has grown continuously. However, it has also gained knowledge of plastic injection moulding and uses ALLROUNDERS to encapsulate special safety screws and other metal parts to this day. However, OBE had to learn how to process metal powders virtually step-by-step. "It was quite brave of us, because at that time this process was



Eight ALLROUNDER machines use the MIM process to produce parts for a variety of industries, including precision components for medical technology (top) and the "Flex-Uno" fastener for spectacle hinges (above).

still in its infancy in Germany," remembers Josef Heckert: "With MIM, we have now achieved a previously unattainable complexity of shape for our components, as well as high production volumes."

Because ARBURG is a pioneer of the powder injection moulding process, and the plastic injection moulding machines and service worked perfectly, OBE decided to also use the Lossburg company

# Spectacle hinges Surgical instruments

markets with metal injection moulding components



Photos: OBE

for its MIM requirements. Production is carried out on appropriately equipped ALLROUNDERS with clamping forces up to 600 kN. Due to the abrasive properties of the metal powder, they feature highly wear-resistant cylinder modules and specially adapted screw geometries. The moulded green compact, as it is called, is removed by a MULTILIFT V robotic system, which sets down the sensitive components according to a pattern in trays.

## Virtually unlimited design freedom

The process offers almost unlimited freedom of design and enables the series production of parts that cannot be produced by machining or pressing – at least not cost effectively.

Transverse holes, undercuts, threads and gears can be achieved with ease within the mould itself. Furthermore, the process saves on resources by regranulating the sprues after the injection process.

Josef Heckert, Technical Manager at OBE, introduced the MIM process at the firm: "Since then, we have been able to produce components with a previously unattainable complexity of form."

## Ideal: Walnut-sized parts

OBE manufactures components weighing between 0.001 and 20 g. Ideal MIM parts are no larger than a walnut. The product range includes spectacle hinges, watch casements, surgical instrument components, delicate valve timing components for passenger cars, titanium fixing elements that are used in the Airbus 380 and many more. One innovative product, which has received an award from the European Powder Metallurgy Association (EPMA), is the "Flex-Uno" spectacle fastener. This subassembly of a resilient hinge can only be mass-produced cost effectively using the MIM process.

In order to be as flexible as possible and independent from upstream suppliers, OBE integrated its own mould making shop for its existing machine fleet in 2007. Eight MIM machines are currently in use in production to process materials such as nickel-free stainless steel, titanium, as well as soft magnetic and super alloys. Furthermore, OBE offers additional services, such as coatings and, above all, surface engineering. "Thanks to our excellent added value, we are able to manufacture complete products according to customer requests," says Josef Heckert with optimism for the future.

## INFOBOX

**Founded:** 1904, OBE Ohnmacht & Baumgärtner GmbH & Co. KG

**Locations:** Germany (production), Italy, Hong Kong, China

**Products:** Spectacle hinges, high-precision MIM components, safety screws, surface monitoring systems

**Industries:** Optics, telecommunications, automotive, medical technology, aviation

**Contact:** [www.obe.de](http://www.obe.de)





# TECH TALK

Dipl.-Ing. (BA) Oliver Schäfer, Technical Information



# Reaching the goal qu

## SELOGICA features for efficient production

**A** machine is only ever as good as its control system. To be able to work really efficiently at the lowest unit costs, extensive control options are required. And these must cover all daily production operations, starting with set-up all the way to individual process optimisation, monitoring and documentation.

In precisely these areas, the SELOGICA control system offers a large range of functions. What is particularly interesting is that the achievable time and cost advantages can be attained immediately. Unmanned preparation is a prime example of this.

### Starting production quickly

Here, the cylinder module of a machine can be heated up exactly as required before each shift using an automatic On/Off function (Fig. 1). It should also be borne in mind that the larger the injection unit, the longer the heating time and the greater the achievable savings potential. Supplemented with the option of programming individual start-up sequences, waiting times before the start of production can be avoided. For machines with a size 800 injection unit, for example, up to 120 hours of production can be gained over 288 working days.

The SELOGICA features a second programming level, the so-called prepara-

tory level, for optimum preparation during order changes. The settings for new processes can be made during running production.

In addition, so-called start-up parameters (Fig. 2) ensure that production gets off to a fast and reliable start. These enable specific machine settings to be made during the start-up phase until production is running in a stable manner. In principle, any of the process parameters can be very simply defined as start-up parameters. All adaptations necessary for start-up can be carried out in a clear and logical manner on a separate screen page, without changing the process parameters. Moreover, the start-up cycles can be individually defined. The result is an automated start-up circuit.

What is particularly useful is that this is saved together with the data record.

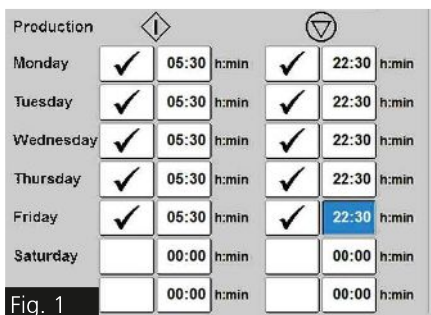

Fig. 1

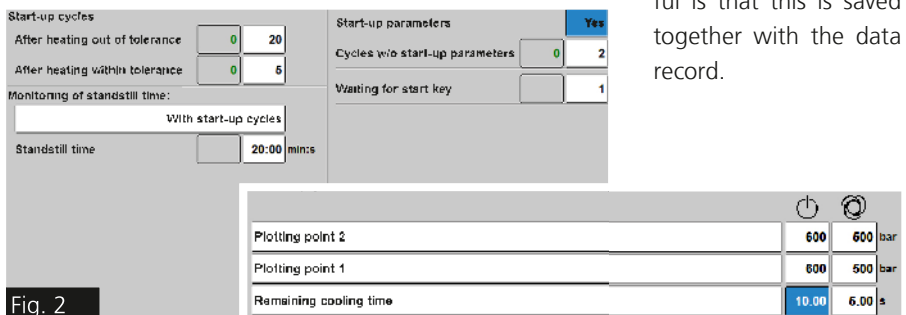

Fig. 2



# ickly and comfortably

## Optimising the production sequence

The cycle time diagram (Fig. 3) is a virtually universal tool for optimising cycle times. Using this, the current run times of each individual cycle step in the production sequence is graphically contrasted with previously defined reference values. Moreover, the cycle steps are broken down into start, delay and run times. In this way, all the necessary information for analysing and optimising the entire production sequence is available on a single screen page. Consequently, delay times programmed during setup can be progressively reduced or simultaneous movements perfectly co-ordinated following the start of production, for example. The operator

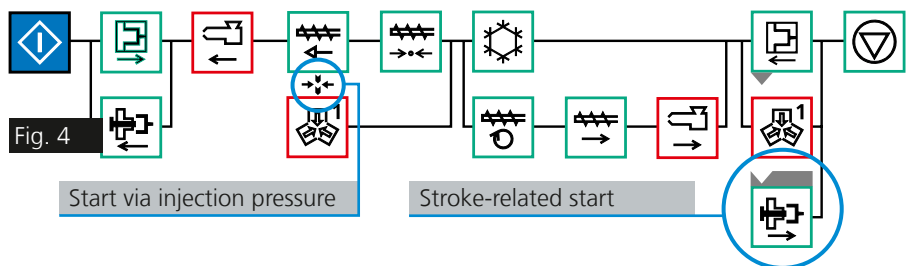

can also quickly assess the stability of the production process. Any deviations that occur can be allocated immediately to the respective function, without having to open individual parameter pages.

Another useful feature of the SELOGICA for simultaneous movements are the starting conditions (Fig. 4). These allow pressure or stroke-related starting, whichever is required to optimise the process.

For example, the ejector or the robotic system movement sequence can already be started during the mould opening movement, in order to reduce the cycle time to a minimum. This way, the ideal production sequence can be configured as desired to suit the specific application using the standard software, with no need for special programs.

Icon	Reference value	10.748 [s]	4.190	10.750 [s]	0.000	0.000	0.000
Fig. 3					0.000	0.000	0.000
					0.000	0.000	2.298
					0.038	0.000	2.304
					2.302	0.200	1.291
					2.346	0.200	1.291
					2.302	0.000	0.001
					2.346	0.000	0.001
					3.592	0.000	1.252
					3.636	0.000	0.544





**Customised series production.** Milestones of the ALLROUNDER principle: Variety of working positions. Multi-component injection moulding. Modularity. Automation. VARIO principle. Displaceable injection unit. Vertical and rotary table ALLROUNDERS. SELOGICA machine control system. Today: Unique range of technologies. Highly modular. Customised to meet any production requirements. The ALLROUNDER: 50 years of innovation. To be continued...



**ARBURG GmbH + Co KG**  
 Postfach 11 09 · 72286 Lossburg  
 Tel.: +49 (0) 74 46 33-0  
 Fax: +49 (0) 74 46 33 33 65  
 e-mail: contact@arburg.com

